

Multi-touch LCD Module Second Edition

User Manual

01010101010100101011101010010101001001010101010010101010101010010110101011011000101111010011010
10101010100010101010101010010101110101001010010010101010101010101010010110101011011000101111010011010
1010101010001010101010101001010111010100101010010010101010101010101001010101010101010100101101010110
10101010100010101010101010010101110101001010100100101010101010101010010101010101010101001010101010101010
10101010100010101010101001010111010100101010010010101010101010101010101010101010101011010010111010011010
10101010100010101010101010010101110101001010010010101010101010101010101010101010101011000101111010011010
101010101000101010101010100101011101010010100100101010101010101010101010101010101010110100101111010011010
101010101000101010101010100101011101010010100100101010101010101010101010101010101010110100101111010011010



| | | |
|------------------|--|-----------|
| Chapter 1 | Introduction | 3 |
| 1.1 | About the Package | 3 |
| 1.2 | External Power Supply for MTL2 | 4 |
| 1.3 | Assembly | 5 |
| 1.4 | Connectivity | 6 |
| 1.5 | Getting Help | 7 |
| Chapter 2 | Architecture of MTL2 | 8 |
| 2.1 | Features | 8 |
| 2.2 | MTL2 Kit | 8 |
| 2.3 | Component and Layout | 8 |
| 2.4 | IDE Cable | 11 |
| 2.5 | ITG Adapter | 11 |
| Chapter 3 | Using the MTL2 | 13 |
| 3.1 | Pin Definition of 2x20 GPIO Connector | 13 |
| 3.2 | Using LCD | 15 |
| 3.3 | Using Terasic Multi-touch IP | 16 |
| Chapter 4 | ePhoto Demonstration | 20 |
| 4.1 | Operation Description | 20 |
| 4.2 | Block Diagram of the ePhoto Design | 21 |
| 4.3 | Loading Photos into FLASH | 22 |
| 4.4 | Demonstration for Terasic DE2-115 FPGA Board | 23 |
| 4.5 | Custom Display Photo | 24 |
| Chapter 5 | Painter Demonstration | 26 |
| 5.1 | Operation Description | 26 |
| 5.2 | System Description | 27 |

| | |
|--|-----------|
| 5.3 Demonstration for Terasic DE2-115 FPGA Board | 28 |
| 5.4 Demonstration Source Code | 30 |
| Chapter 6 Appendix..... | 31 |
| 6.1 Revision History | 31 |
| 6.2 Copyright Statement | 31 |

The New Terasic Multi-touch LCD Module Second Edition (MTL2) is an all-purpose capacitive touch-screen for FPGA applications and provides five points multi-touch gesture support. An IDE cable with an IDE to GPIO (ITG) adapter is used to interface with various Terasic FPGA development boards through a 2x20 GPIO interface on the MTL2. The kit contains complete reference designs and source code for an ePhoto demonstration and Painter application. This chapter provides the key information about the kit.

1.1 About the Package

The MTL2 kit comes with the following contents:

- Multi-touch LCD Module Second Edition
- IDE Cable with ITG Adapter
- 5V Power Supply
- Four Silicon Footstands

Users can download MTL2 system CD form <http://cd-mtl2.terasic.com>. The system CD contains technical documents of the MTL2 kit, which includes component datasheets, demonstrations, schematic, cable and user manual.

Figure 1-1 shows the contents of MTL2 kit.

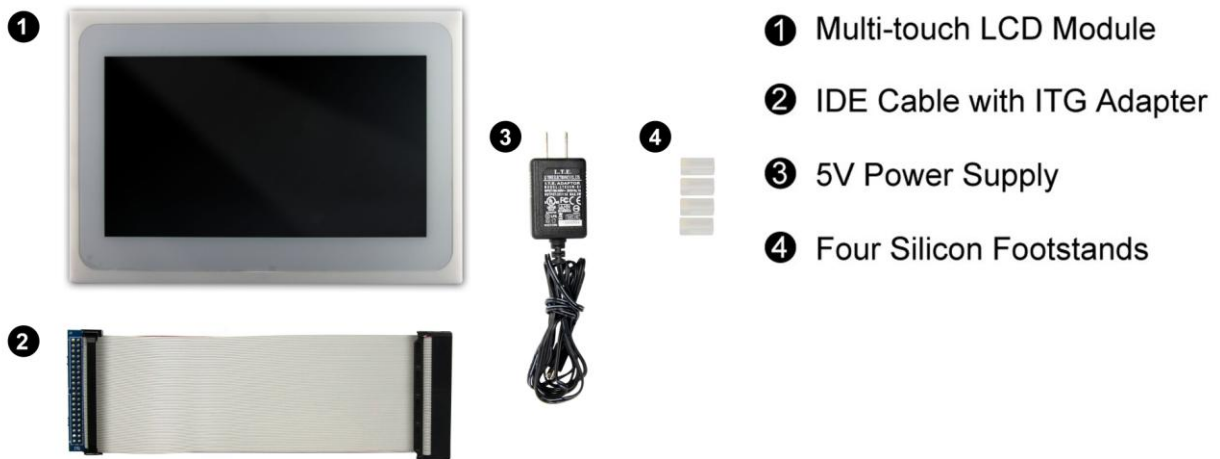

Figure 1-1 Contents of MTL2 Kit

1.2 External Power Supply for MTL2

Figure 1-2 shows the power adapter for the MTL2. Due to the fact that the LCD panel in the MTL may consumes more power than some FPGA boards can provide, a dedicated power adapter for MTL2 is required as shown in Figure 1-3.



Figure 1-2 MTL2 Power Adapter

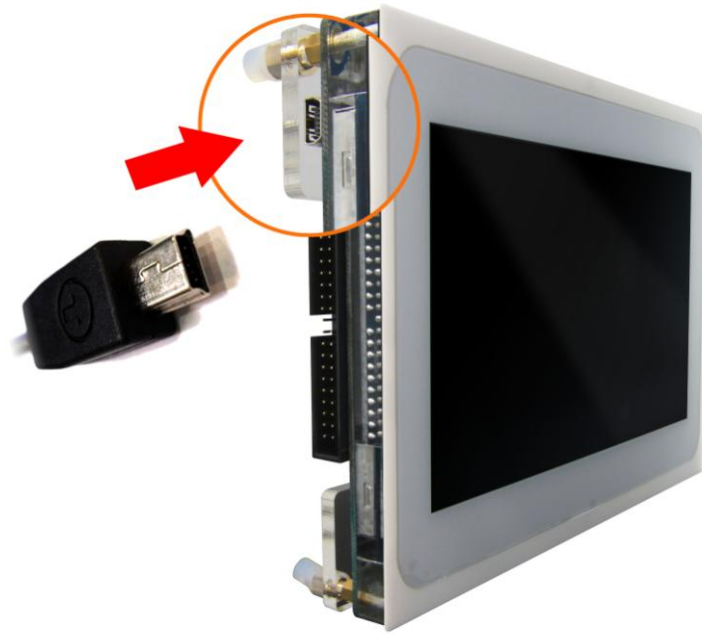

Figure 1-3 External USB Power Connection Setup

1.3 Assembly

Here are the procedures to assemble the MTL2 kit:

1. Connect the IDE cable to the IDE connector on the back of the MTL as shown in the **Figure 1-4**.

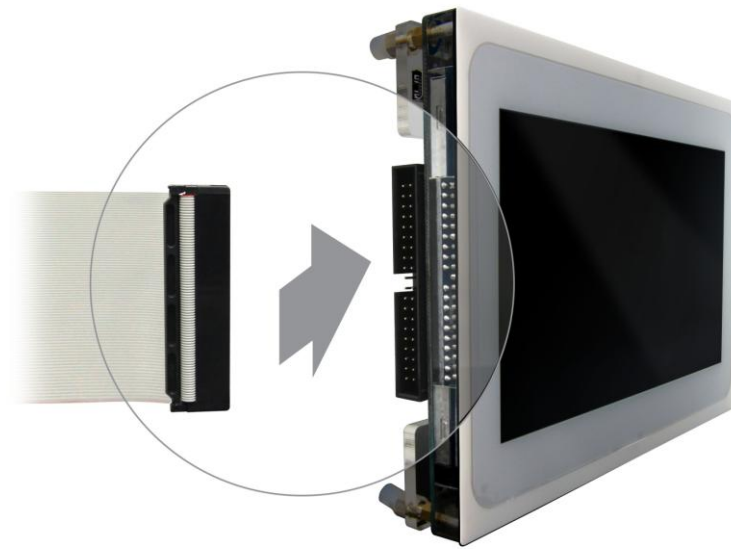

Figure 1-4 MTL connection for the IDE cable

2. Place four silicon footstands to foot pegs of the MTL2 as shown in **Figure 1-5**.

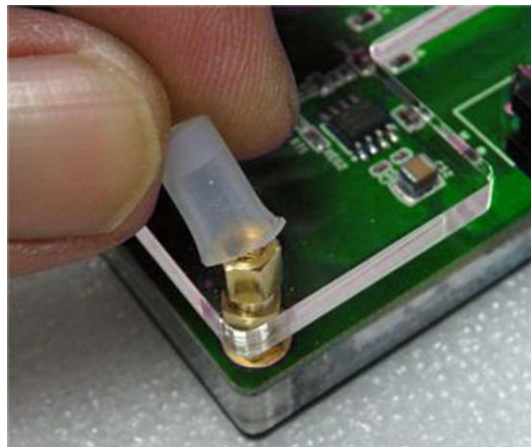

Figure 1-5 MTL2 Footstand Setup

1.4 Connectivity

The following figures show the connectivity for MTL2 to DE2-115 and DE1-SoC FPGA Development Boards.



Figure 1-6 MTL2 with DE2-115



Figure 1-7 MTL2 with DE1-SoC

1.5 Getting Help

Here is information of how to get help if you encounter any problem:

- Office Hours: 9:00 a.m. to 6:00 p.m. (GMT +8)
- Telephone: +886-3-550-8800
- Email: support@terasic.com

Architecture of MTL2

This chapter provides information regarding features and architecture of the MTL2.

2.1 Features

The key features of this module are listed below:

- 800x480 pixel resolution LCD with 24-bit color depth
- Five-point touch support
- Gesture support
- IDE interface
- 2x20 GPIO interface with ITG adapter

2.2 MTL2 Kit

The MTL2 kit is assembled via three components:

- Multi-touch LCD Module
- IDE Cable
- IDE to GPIO (ITG) adapter

The IDE cable is used to provide a high-speed signal transmission for 33 MHz video signals. The ITG adapter is designed to map the standard IDE pin assignment to the 2x20 GPIO interface on the FPGA boards.

2.3 Component and Layout

The top view of MTL2 is shown in **Figure 2-1**.



Figure 2-1 MTL2 Top View

The bottom view of MTL2 is shown in **Figure 2-2**. It depicts the layout and indicates the locations of connectors and key components.



Figure 2-2 MTL2 Bottom View

Block Diagram

Figure 2-3 shows the block diagram of MTL2. The IDE connector houses all the wires from peripheral interfaces, connecting to the FPGA of a development kit through the IDE cable and ITG adapter.

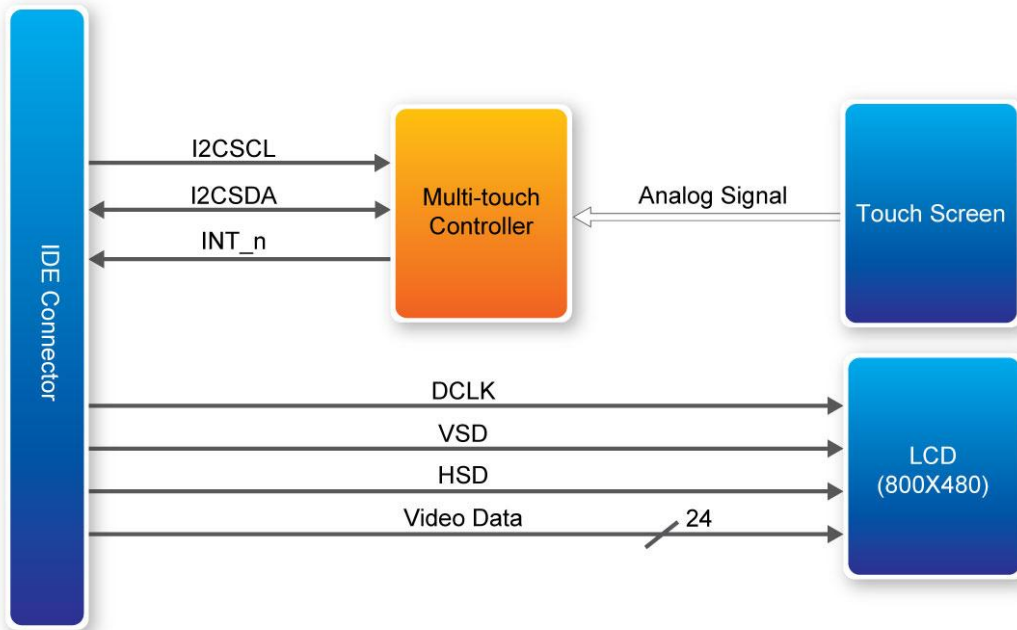

Figure 2-3 Block Diagram of MTL2

Figure 2-4 illustrates the connection for MTL2 to the Terasic FPGA boards.

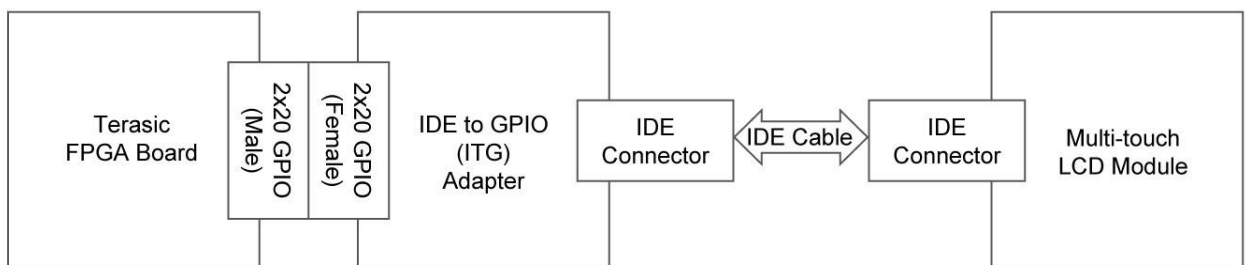

Figure 2-4 Connection Diagram of MTL2 Kit with Terasic FPGA boards

2.4 IDE Cable

The connection cable included is a standard IDE cable. However, to achieve the best performance, we strongly recommend users use the bundled IDE cable only. Third-party IDE cables may cause the MTL2 to malfunction, or even damage the module. The IDE cable is shown in **Figure 2-5**.

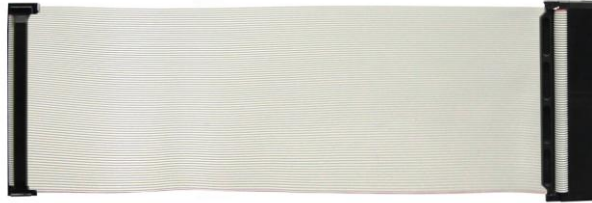

Figure 2-5 IDE cable

2.5 ITG Adapter

The IDE to GPIO (ITG) adapter is designed to remap IDE pins to GPIO pins.

Figure 2-6 and **Figure 2-7** show the top view and bottom view of ITG adapter, respectively.

The J1 connector is used to connect the FPGA board. The J2 connector is used to interface with the IDE cable.

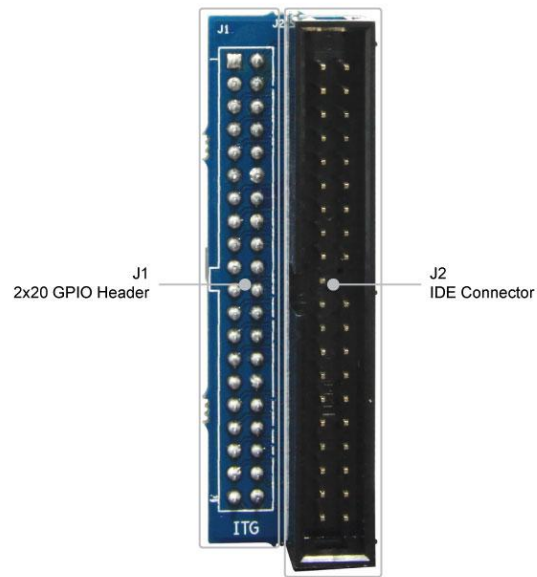

Figure 2-6 ITG Adapter (Top View)

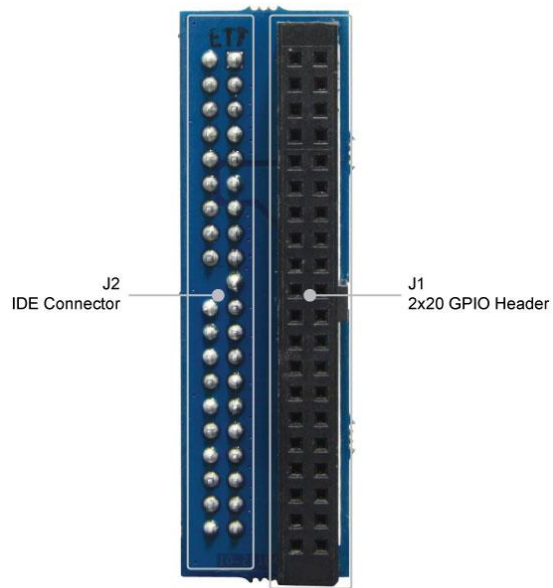

Figure 2-7 ITG Adapter (Bottom View)

Using the MTL2

This chapter provides information on how to control the MTL2 hardware, including definition of 2x20 GPIO interface, LCD control, and multi-touch control signals.

3.1 Pin Definition of 2x20 GPIO Connector

The 2x20 GPIO female connector is designed to directly connect to the 2x20 GPIO male connector on the Terasic FPGA development boards. **Figure 3-1** shows the signal names of the 2x20 GPIO from the ITG adapter.

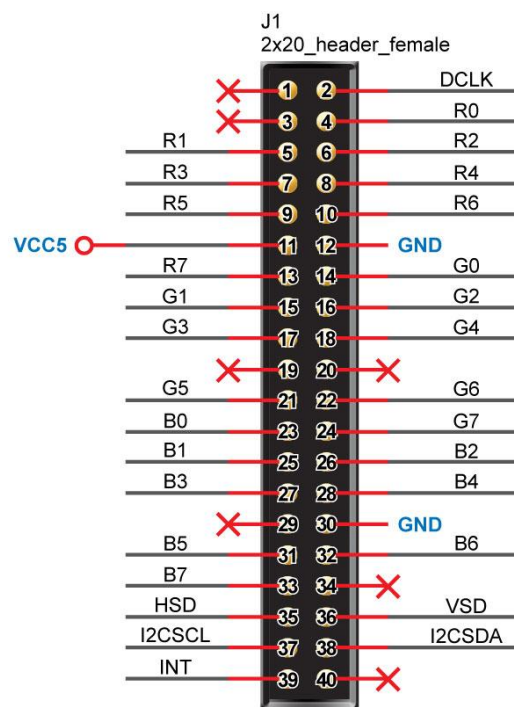

Figure 3-1 2x20 GPIO

Table 3-1 shows the recommended pin assignments for the 2x20 GPIO pins in Quartus II.

Table 3-1 Recommended Pin Assignments of 2x20 GPIO in Quartus II

| <i>Pin Numbers</i> | <i>Pin Name</i> | <i>Direction</i> | <i>IO Standard</i> |
|--------------------|-------------------|------------------|--------------------|
| 1 | - | - | - |
| 2 | MTL_DCLK | Output | 3.3-V LVTTL |
| 3 | - | - | - |
| 4 | MTL_R[0] | Output | 3.3-V LVTTL |
| 5 | MTL_R[1] | Output | 3.3-V LVTTL |
| 6 | MTL_R[2] | Output | 3.3-V LVTTL |
| 7 | MTL_R[3] | Output | 3.3-V LVTTL |
| 8 | MTL_R[4] | Output | 3.3-V LVTTL |
| 9 | MTL_R[5] | Output | 3.3-V LVTTL |
| 10 | MTL_R[6] | Output | 3.3-V LVTTL |
| 11 | - | - | - |
| 12 | - | - | - |
| 13 | MTL_R[7] | Output | 3.3-V LVTTL |
| 14 | MTL_G[0] | Output | 3.3-V LVTTL |
| 15 | MTL_G[1] | Output | 3.3-V LVTTL |
| 16 | MTL_G[2] | Output | 3.3-V LVTTL |
| 17 | MTL_G[3] | Output | 3.3-V LVTTL |
| 18 | MTL_G[4] | Output | 3.3-V LVTTL |
| 19 | - | - | - |
| 20 | - | - | - |
| 21 | MTL_G[5] | Output | 3.3-V LVTTL |
| 22 | MTL_G[6] | Output | 3.3-V LVTTL |
| 23 | MTL_B[0] | Output | 3.3-V LVTTL |
| 24 | MTL_G[7] | Output | 3.3-V LVTTL |
| 25 | MTL_B[1] | Output | 3.3-V LVTTL |
| 26 | MTL_B[2] | Output | 3.3-V LVTTL |
| 27 | MTL_B[3] | Output | 3.3-V LVTTL |
| 28 | MTL_B[4] | Output | 3.3-V LVTTL |
| 29 | - | - | - |
| 30 | - | - | - |
| 31 | MTL_B[5] | Output | 3.3-V LVTTL |
| 32 | MTL_B[6] | Output | 3.3-V LVTTL |
| 33 | MTL_B[7] | Output | 3.3-V LVTTL |
| 34 | - | - | - |
| 35 | MTL_HSD | Output | 3.3-V LVTTL |
| 36 | MTL_VSD | Output | 3.3-V LVTTL |
| 37 | MTL_TOUCH_I2C_SCL | Output | 3.3-V LVTTL |

| | | | |
|----|-------------------|-------|--------------|
| 38 | MTL_TOUCH_I2C_SDA | Inout | 3.3-V LVTTTL |
| 39 | MTL_TOUCH_INT_n | Input | 3.3-V LVTTTL |
| 40 | - | - | - |

3.2 Using LCD

The LCD features 800x480 pixel resolution and runs at 33 MHz pixel rate. There is no configuration required to drive the LCD. The timing specification is defined as in the **Table 3-2**, **Table 3-3**, **Figure 3-2** and **Figure 3-3**.

Table 3-2 LCD Horizontal Timing Specifications

| <i>Item</i> | <i>Symbol</i> | <i>Typical Value</i> | | | <i>Unit</i> |
|-------------------------|---------------|----------------------|-------------|-------------|-------------|
| | | <i>Min.</i> | <i>Typ.</i> | <i>Max.</i> | |
| Horizontal Display Area | thd | - | 800 | - | DCLK |
| DCLK Frequency | fclk | 26.4 | 33.3 | 46.8 | MHz |
| One Horizontal Line | th | 862 | 1056 | 1200 | DCLK |
| HS pulse width | thpw | 1 | | 40 | DCLK |
| HS Blanking | thb | 46 | 46 | 46 | DCLK |
| HS Front Porch | thfp | 16 | 210 | 354 | DCLK |

Table 3-3 LCD Vertical Timing Specifications

| <i>Item</i> | <i>Symbol</i> | <i>Typical Value</i> | | | <i>Unit</i> |
|-----------------------|---------------|----------------------|-------------|-------------|-------------|
| | | <i>Min.</i> | <i>Typ.</i> | <i>Max.</i> | |
| Vertical Display Area | tvd | - | 480 | - | TH |
| VS period time | tv | 510 | 525 | 650 | TH |
| VS pulse width | tvpw | 1 | - | 20 | TH |
| VS Blanking | tvb | 23 | 23 | 23 | TH |
| HS Front Porch | tvfp | 7 | 22 | 147 | TH |

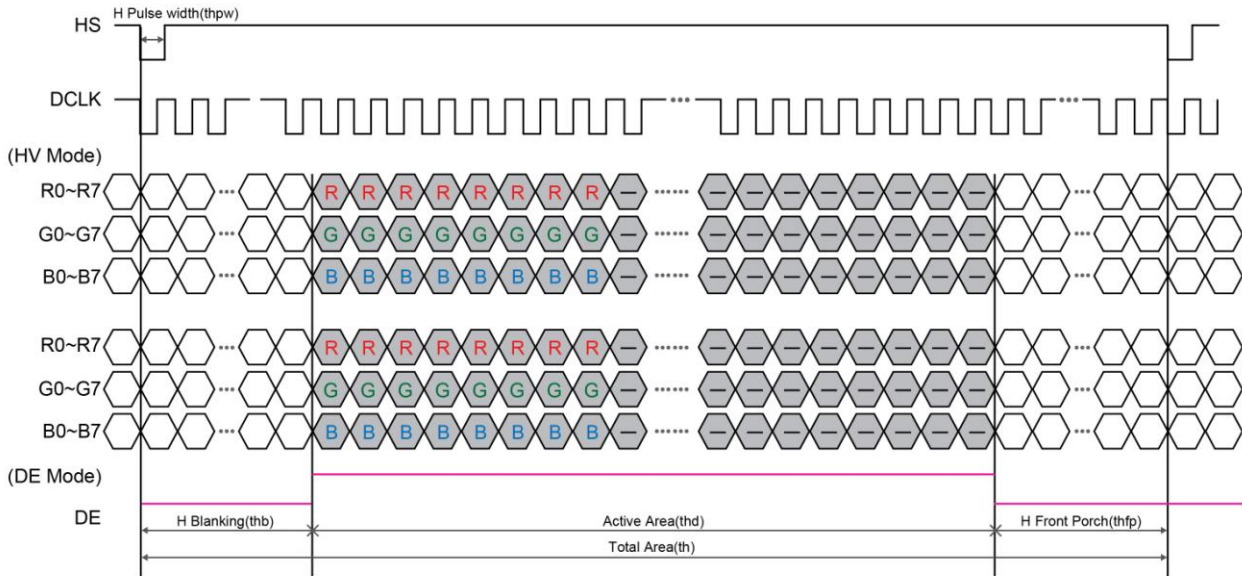

Figure 3-2 Horizontal input timing waveform

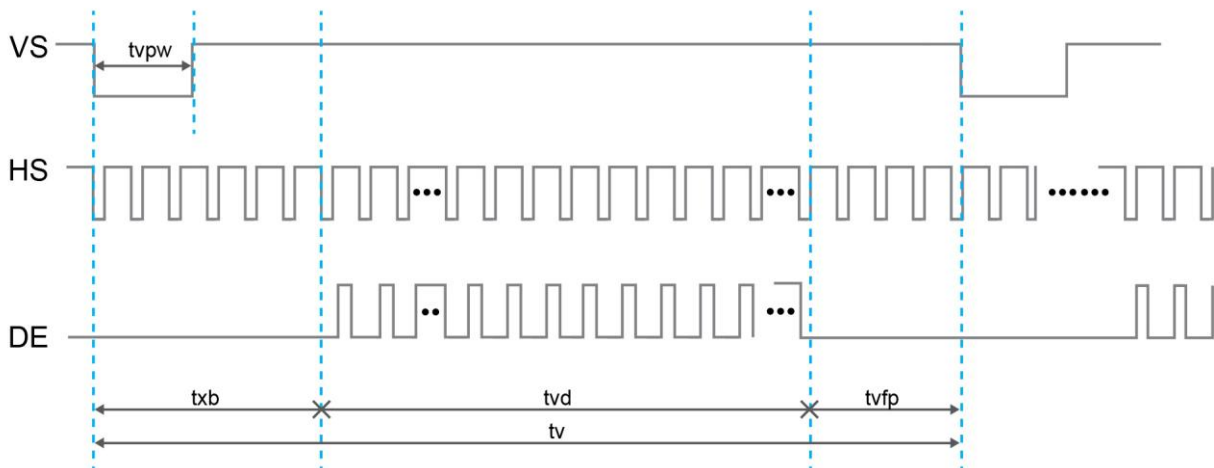

Figure 3-3 Vertical input timing waveform

3.3 Using Terasic Multi-touch IP

Terasic Multi-touch IP is provided for developers to retrieve user inputs, including multi-touch gestures and single-touch. The file name of this IP is **i2c_touch_config.v**, which is located in System CD \IP folder.

The IP decodes I2C information and outputs coordinates and gesture information. The inputs and outputs of this IP module is shown below

```

module i2c_touch_config(
    //Host Side
    iCLK,
    iRSTN,
    oREADY,
    INT_n,
    oREG_X1,
    oREG_Y1,
    oREG_X2,
    oREG_Y2,
    oREG_X3,
    oREG_Y3,
    oREG_X4,
    oREG_Y4,
    oREG_X5,
    oREG_Y5,
    oREG_GESTURE,
    oREG_TOUCH_COUNT,
    //I2C Side
    I2C_SDAT,
    I2C_SCLK
);

```

The purpose of signals for this IP is described in **Table 3-4**. The IP requires a 50 MHz signal as a reference clock to the **iCLK** pin and system reset signal to the **iRSTN**. **INT_n**, The signals of **I2C_SCLK**, and **I2C_SDAT** pins should be connected to the **MTL_TOUCH_INT_n**, **MTL_TOUCH_I2C_SCL**, and **MTL_TOUCH_I2C_SDA** signals in the 2x20 GPIO header, respectively.

When touch activity occurs, the control application should check whether the value of **oREG_GESTURE** matches a pre-defined gesture ID defined in **Table 3-4** and the relative X/Y coordinates can be derived from **oREG_X** and **oREG_Y**. **Figure 3-1** shows the signaltap II waveform of the IP. When the **oREADY** rises, it indicates touch activity, and the associated information can be collected from the **oREG_X1~ oREG_X5**, **oREG_Y1~ oREG_Y5**, **oREG_TOUCH_COUNT**, and **oREG_GESTURE** pins.

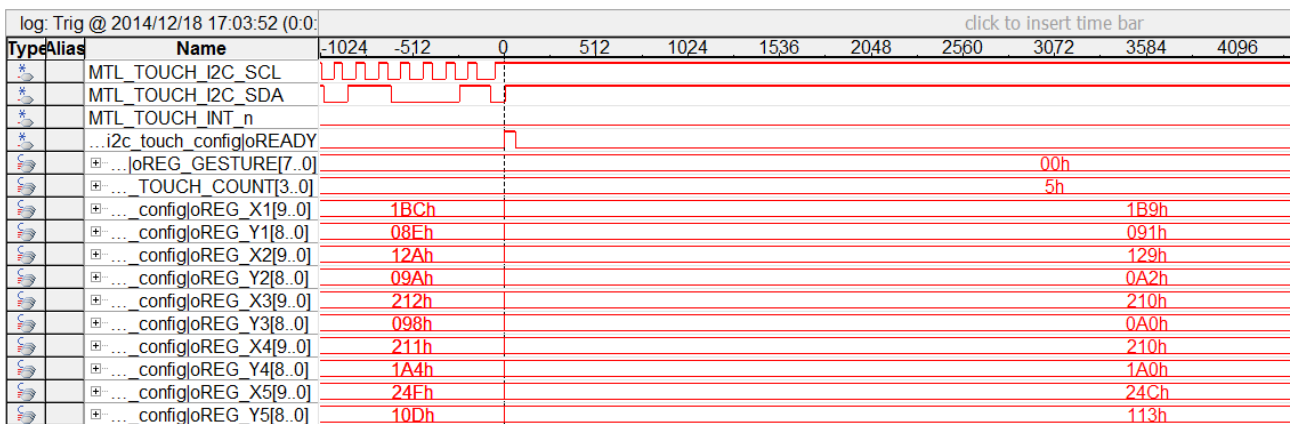

Figure 3-4 SignalTap II Waveform for Multi-Touch IP

Table 3-4 Definition of Terasic Multi-touch IP Signals

| <i>Pin Name</i> | <i>Direction</i> | <i>Description</i> |
|------------------|------------------|--|
| iCLK | Input | Connect to 50MHz clock |
| iRSTN | Input | Connect to system reset signal |
| INT_n | Input | Connect to interrupt pin of touch IC |
| oREADY | Output | Triggered when the data of following six outputs are valid |
| oREG_X1 | Output | 10-bit X coordinate of first touch point |
| oREG_Y1 | Output | 9-bit Y coordinate of first touch point |
| oREG_X2 | Output | 10-bit X coordinate of second touch point |
| oREG_Y2 | Output | 9-bit Y coordinate of second touch point |
| oREG_X3 | Output | 10-bit X coordinate of first touch point |
| oREG_Y3 | Output | 9-bit Y coordinate of second touch point |
| oREG_X4 | Output | 10-bit X coordinate of first touch point |
| oREG_Y4 | Output | 9-bit Y coordinate of second touch point |
| oREG_X5 | Output | 10-bit X coordinate of first touch point |
| oREG_Y5 | Output | 9-bit Y coordinate of second touch point |
| oREG_TOUCH_COUNT | Output | 2-bit touch count. Valid value is 0, 1, or 2. |
| oREG_GESTURE | Output | 8-bit gesture ID (See Table 3-5) |
| I2C_SCLK | Output | Connect to I2C clock pin of touch IC |
| I2C_SDAT | Inout | Connect to I2C data pin of touch IC |

The gestures and IDs supported are shown in [Table 3-5](#).

Table 3-5 Gestures and Its IDs

| <i>Gesture</i> | <i>ID (hex)</i> |
|-----------------------|------------------------|
| Move Up | 0x10 |
| Move Left | 0x14 |
| Move Down | 0x18 |
| Move Right | 0x1C |
| Zoom In | 0x48 |
| Zoom Out | 0x49 |
| No Gesture | 0x00 |

Note: The Terasic IP Multi-touch IP can also be found under the \IP folder in the system CD, as well as the reference designs.

ePhoto Demonstration

This chapter describes how to use MTL2 to design a simple HDL code to implement a photo viewer. The demonstration can support the following Terasic FPGA boards:

- DE2-115

4.1 Operation Description

This demonstration implements a simple photo viewer. Before running this demonstration, three 800x480 photos should be vertically merged into one 800x1440 photo and be stored in FLASH of the FPGA board in advance. In this demonstration, users can browse each photo by using single touch "move right" or "move left" gesture to select the previous or next photo, as shown in **Figure 4-1**.



Figure 4-1 Select Next Photo by East Gesture

Also, users can use two-point zoom-in and zoom-out gestures to zoom the photo displayed, as shown in **Figure 4-2**.

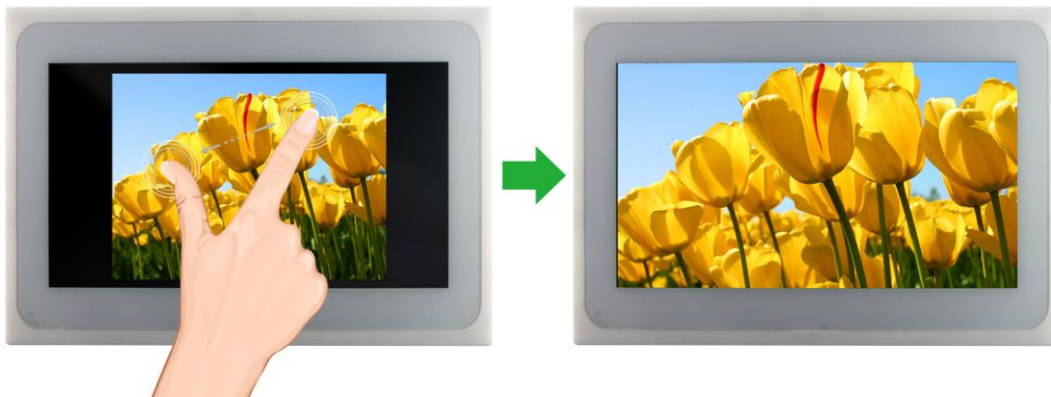

Figure 4-2 Zoom-in using Zoom-in Gesture

4.2 Block Diagram of the ePhoto Design

This section describes the block diagram of the ePhoto demonstration to give users a better understanding of the code provided.

Figure 4-3 shows the block diagram of the ePhoto demonstration. When the demonstration starts up, the system will control the *Flash Controller* to read the RGB data of three photos stored in the FLASH, and write the data into SDRAM by using the writing port of the *SDRAM*. The *SDRAM Controller* provides two reading ports and two writing ports. In this demonstration, only one reading port and one write porting are used. To display the selected photo on the 800x480 LCD, the *VGA Controller* will retrieve the photo data via reading the port of the *SDRAM*, and drive the LCD display with the retrieved photo data. The *VGA Controller* retrieves the photo data at a rate of 60 photos per second. *Zoom* handles the photo zooming process. The displayed photo is zoomed before being sent to the LCD display.

When users touch the MTL2 screen, *I2C Touch Config* will receive an interrupt signal from the touch screen. When an interrupt is detected, *I2C Touch Config* will read touch information from the touch panel and assert the oREADY signal. When *Touch Controller* detects a rising signal of oREADY, it will read touch information and determine the input, which may be a gesture or a single-point touch. If a west or east gesture is detected, it will change the reading port address of the desired active photo in the *SDRAM Controller*. If a zoom-in or zoom-out gesture is detected, it will change the zooming factor in *Zoom*.

For multi-touch gesture processing, a Terasic Memory-Mapped IP *I2C_Touch_Config* is used to retrieve the touch information. For IP-usage details, please refer to the Chapter 3 in this document. Note: the IP is encrypted, so the license should be installed before compiling the Quartus II project.

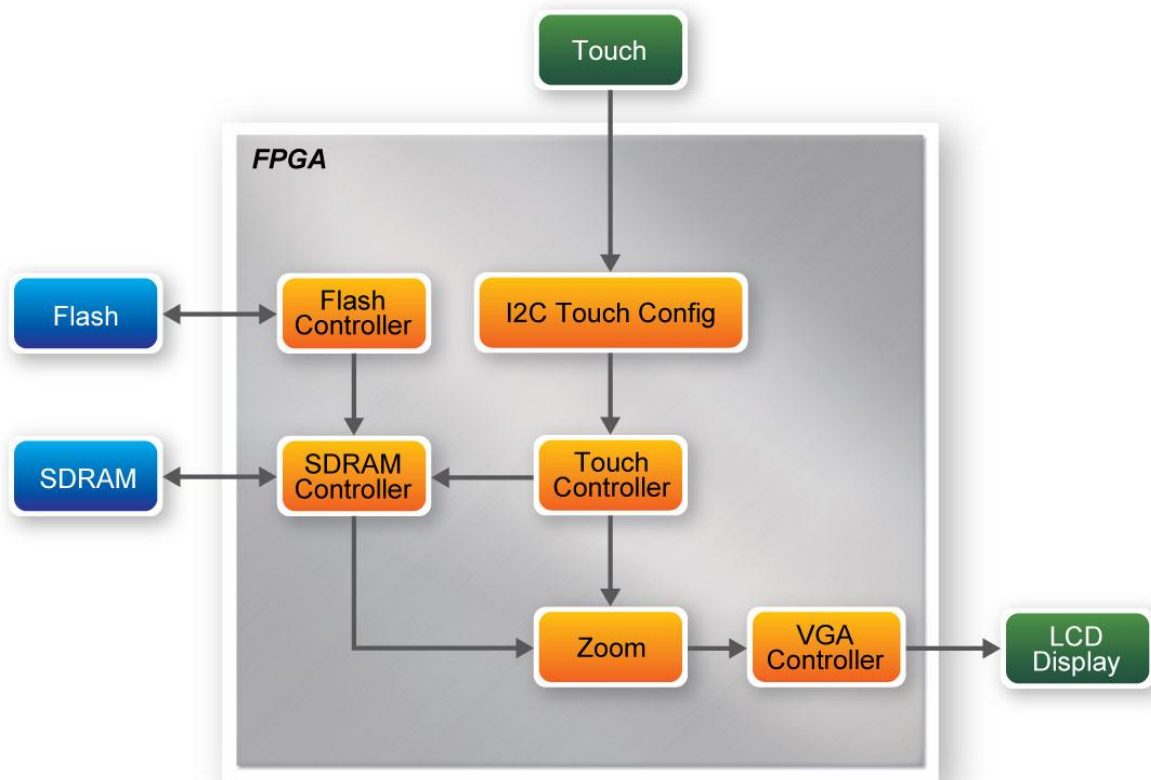

Figure 4-3 The Block Diagram of the ePhoto Demonstration

4.3 Loading Photos into FLASH

Before executing the demonstration, users have to utilize the Control Panel software to load photos into the FLASH of the FPGA board first. The Control Panel software is available in the CD of the FPGA development kit.

Procedure for loading photos to FLASH:

1. Make sure the USB-Blaster download cable is connected to the host PC.
2. Power on the FPGA Development Board.
3. Execute the Control Panel application software. Please refer to the user manual of the FPGA development kit for more information for the Control Panel software.
4. Switch to the FLASH page and click on the “Chip Erase (xx Sec)” button to erase FLASH data.
5. Click on the “File Length” checkbox to indicate that you want to load the entire file.
6. Click on the “Write a File to FLASH” button. When the Control Panel responds with the standard Windows dialog box and asks for the source file, select the “DEMO.raw” file in the “Demonstrations\RTL\Photo” directory
7. When loading is completed, a prompt will appear indicating success.

4.4 Demonstration for Terasic DE2-115 FPGA Board

This section shows how to setup the painter demo on the Terasic DE2-115 FPGA Board. For other Terasic FPGA boards, the setup procedures are similar.

Hardware Setup

The demonstration configuration is as shown in **Figure 4-4**. Make sure the ITG adapter is connected firmly to the IDE cable. Plug the ITG adapter into the GPIO-0 header of the FPGA development kit from MTL2 before turning on. Important: Plug the MTL2 power adaptor into the power connector of MTL2 unless the DE2-115 FPGA board is used.



Figure 4-4 DE2-115 ePhoto Configuration Setup

Execute Demonstration

Procedure to execute demonstration:

1. Make sure the DE2-115 is powered off.
2. Mount the ITG adapter onto the 2x20 GPIO 0 expansion header of the DE2-115.
3. Connect the DE2-115 USB-Blaster USB port to the PC USB Port with a USB Cable.
4. Power on the DE2-115 FPGA Development Board.
5. Make sure Quartus II 13.1 and NIOS II 13.1 are installed in your system.
6. If you haven't already, store pictures into the flash memory. For more detailed instructions please refer to section 4.3 *Loading Photos into FLASH*.
7. Copy the folder Demonstrations\RTL\DE2_115_MTL2_EPHOTO\demo_batch in the MTL2 System CD onto your system and execute "test.bat".
8. A photo should be displayed in the LCD, as shown in **Figure 4-5**.
9. Slide left or right with one finger on the touch panel to display the previous and next photos

respectively.

10. Slide with two fingers in the opposite direction to zoom-in on the picture and pinch two fingers together to zoom the picture out.



Figure 4-5 Photo Display

4.5 Custom Display Photo

Procedure for creating custom photos for ePhoto:

1. Prepare three 24-bit *bitmap* format photos with image resolutions of 800 (width) x 480 (height) pixels for each, as shown in **Figure 4-6**.



Figure 4-6 Original Photo Resolution

2. Use image processing software to vertically merge the three photos into a new photo image with 24-bits color *bitmap* format. The merged photo resolution should be 800 (width) x 1440 (height) pixels, as shown in **Figure 4-7**.
3. Use the tool “bmp_to_raw.exe” in the “Demonstrations\RTL\Photo” directory to convert the picture to raw file. This tool will removing bmp file header that help flash controller read the correct file data.



Figure 4-7 Photo Format for the ePhoto Demonstration

Painter Demonstration

This chapter shows how to implement a painter demo on the Multi-Touch LCD Module based on SOPC Builder and the Altera’s Video and Image Processing Suite (VIP). The design demonstrates how to use multi-touch gestures and single-touch. The demonstration requires the following hardware:

- Terasic FPGA Board
- Multi-touch LCD Module

5.1 Operation Description

Figure 5-1 shows the Graphical User Interface (GUI) of the Painter Demo. The GUI is classified into four separate areas: Painting Area, Gesture Indicator, Clear Button, and Color Palette. Users can select a pen color from the color palette and start painting in the paint area. To clear the painting area, click the “Clear” button.

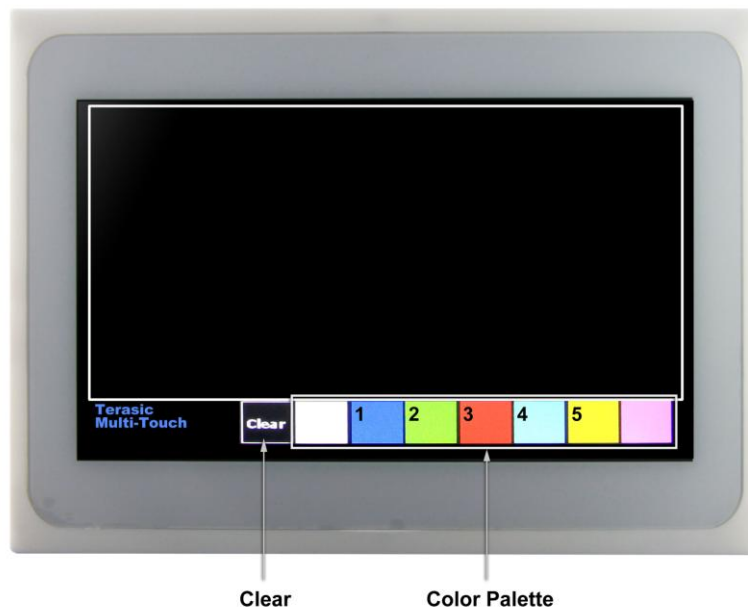

Figure 5-1 GUI of Painter Demo

Figure 5-2 displays the five-finger painting of the canvas area.

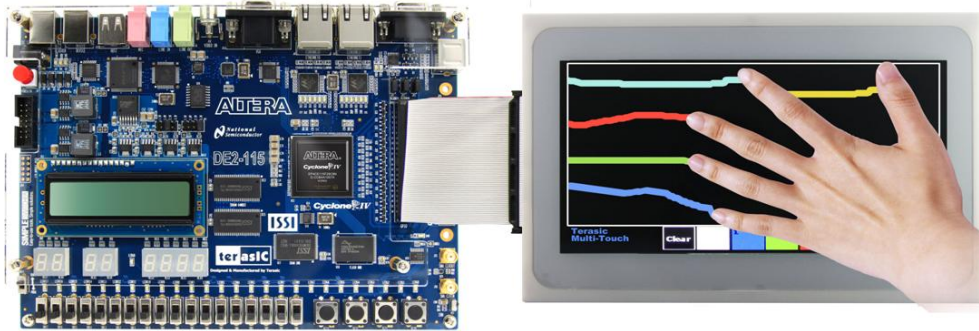

Figure 5-2 Five-finger Painting

5.2 System Description

For LCD display processing, the reference design is developed based on Altera’s Video and Image Processing Suite (VIP). The Frame Reader VIP is used for reading display content from the associated video memory, and VIP Video Out is used to display the display content. The display content is drawn by the NIOS II processor according to user input.

For multi-touch processing, a Terasic Memory-Mapped IP is used to retrieve the user input, including multi-touch gestures and single-touch coordinates. For IP--usage details please refer to the Chapter Three in this document. Note: the IP is encrypted, so the license should be installed before compiling the Quartus II project.

Figure 5-3 shows the system generic block diagram of demonstration reference design.

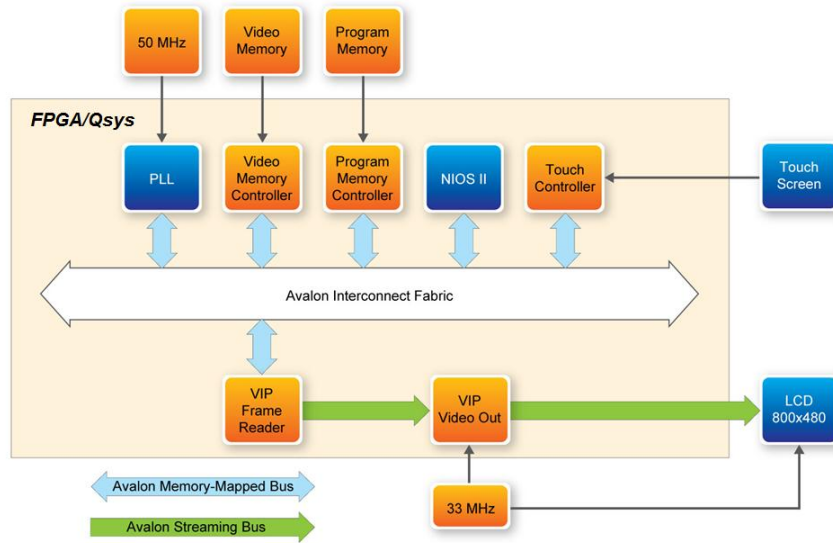

Figure 5-3 System Block Diagram

5.3 Demonstration for Terasic DE2-115 FPGA Board

This section shows how to setup the painter demo on the Terasic DE2-115 FPGA Board. For other Terasic FPGA boards, the setup procedures are similar.

Hardware Setup



Figure 5-4 Hardware Setup with DE2-115



Figure 5-5 Hardware Setup with DE1-SoC



Figure 5-6 Hardware Setup with DE0-Nano



Figure 5-7 Hardware Setup with DE0-CV



Figure 5-8 Hardware Setup with DE2-115

Execute Demonstration

Please follow the procedures below to setup the demonstration:

1. Make sure the DE2-115 is powered off.
2. Mount the ITG adapter onto the 2x20 GPIO 0 expansion header of the DE2-115.
3. Connect the DE2-115 USB-Blaster USB-B port to the PC USB Port with a USB Cable.
4. Power on the DE2-115 FPGA Development Board.
5. Make sure Quartus II 13.1 and NIOS II 13.1 are installed on your system.
6. Copy the folder Demonstrations/Qsys/DE2_115_MTL2_PAINTER/demo_batch in the MTL System CD onto your system and execute “test.bat”.
7. Now, you should see the painter GUI on the LCD.

5.4 Demonstration Source Code

The source code locations of this demonstration for the various Terasic FPGA boards are shown in **Table 5-1**. Note: The project is built under Quartus II 13.1, and both Altera VIP license and Terasic Multi-Touch IP license are required for rebuilding the project.

Table 5-1 Source Code Locations of Painter Demonstration

| FPGA Board | Location |
|-------------------|---|
| DE2 | Demonstrations\Qsys\DE2_MTL2_PAINTER |
| DE2-115 | Demonstrations\ Qsys \DE2_115_MTL2_PAINTER |
| DE1-SoC | Demonstrations\ Qsys \ DE1-SoC _MTL2_PAINTER |
| DE0-Nano | Demonstrations\ Qsys \ DE0-Nano _MTL2_PAINTER |
| DE0-CV | Demonstrations\ Qsys \DE0-CV _MTL2_PAINTER |

6.1 Revision History

| <i>Version</i> | <i>Change Log</i> |
|----------------|---|
| V1.0 | Initial Version (Preliminary) |
| V1.0.1 | Modify Figure 5-2 Description |
| V1.0.2 | Modify Figure 5-7 |
| V1.0.3 | Modify Figure 5-7 change DE0-nano-soc to DE0-nano |

6.2 Copyright Statement

Copyright © 2016 Terasic Technologies. All rights reserved.

We will continue to provide interesting examples and labs on our MTL2 webpage. Please visit mtl2.terasic.com for more information.